

CLARKE®

weld



NO GAS/GAS MIG WELDER

MODEL NO: MIG196

PART NO: 6015200

OPERATION & MAINTENANCE INSTRUCTIONS



ORIGINAL INSTRUCTIONS

GC1121 - rev 11

INTRODUCTION

Thank you for purchasing this CLARKE MIG Welder.

Before attempting to operate the machine, it is essential that you read this manual thoroughly and carefully follow all instructions given. In doing so you will ensure the safety of yourself and that of others around you, and you can also look forward to the welder giving you long and satisfactory service.

GUARANTEE

This CLARKE product is guaranteed against faulty manufacture for a period of 12 months from the date of purchase. Please keep your receipt as proof of purchase.

This guarantee is invalid if the product is found to have been abused or tampered with in any way, or not used for the purpose for which it was intended.

Faulty goods should be returned to their place of purchase, no product can be returned to us without prior permission.

This guarantee does not effect your statutory rights.

ENVIRONMENTAL RECYCLING POLICY



Through purchase of this product, the customer is taking on the obligation to deal with the WEEE in accordance with the WEEE regulations in relation to the treatment, recycling & recovery and environmentally sound disposal of the WEEE.

In effect, this means that this product must not be disposed of with general household waste. It must be disposed of according to the laws governing Waste Electrical and Electronic Equipment (WEEE) at a recognised disposal facility.

SAFETY PRECAUTIONS FOR ALL TYPES OF WELDING



WARNING: AS WITH ALL MACHINERY, THERE ARE CERTAIN HAZARDS INVOLVED WITH THEIR OPERATION AND USE. EXERCISING RESPECT AND CAUTION WILL CONSIDERABLY LESSEN THE RISK OF PERSONAL INJURY. HOWEVER, IF NORMAL SAFETY PRECAUTIONS ARE OVERLOOKED, OR IGNORED, PERSONAL INJURY TO THE OPERATOR MAY RESULT.

FAILURE TO FOLLOW THESE RULES MAY RESULT IN SERIOUS PERSONAL INJURY

GENERAL PRECAUTIONS

A) BURN PREVENTION

Wear protective clothing - gauntlet gloves designed for use in welding, apron, and protective shoes. Button shirt collar and pocket flaps, and wear cuffless trousers to avoid entry of sparks and slag. Wear helmet with safety goggles or glasses with side shields underneath, appropriate filter lenses or plates (protected by clear glass). This is a **MUST** for welding (and chipping) to protect the eyes from radiant energy and spatter. Replace cover glass when broken, pitted, or spattered. Avoid oily greasy clothing. A spark may ignite them. Hot metal should never be handled without gloves. First aid facilities and a qualified first aid person should be available unless medical facilities are close by for immediate treatment of flash burns of the eyes and skin burns. Ear plugs should be worn when working overhead or in a confined space. A hard hat should be worn when others work overhead. Flammable hair preparations should not be used by persons intending to weld or cut.

NOTE: ALL protective wear incl. masks & head shields **MUST** comply with PPE Directive 89/686/EEC

B) TOXIC FUME PREVENTION

Severe discomfort, illness or death can result from fumes, vapours, heat, or oxygen enrichment or depletion that welding (or cutting) may produce. Prevent them with adequate ventilation. **NEVER** ventilate with oxygen. Lead-, cadmium-, zinc-, mercury- and beryllium-, bearing materials, when welded (or cut) may produce harmful concentrations of toxic fumes. Adequate local exhaust ventilation must be used, or each person in the area as well as the operator must wear an air-supplied respirator. For beryllium, both must be used. Metals coated with or containing materials that emit toxic fumes should not be heated unless coating is removed from the work surface, the area is well ventilated, or the operator wears an air-supplied respirator. Work in a confined space only while it is being force ventilated and, if necessary, while wearing an air-supplied respirator. Vapours from chlorinated solvents can be decomposed by the heat of the arc (or flame) to form PHOSGENE, a highly toxic gas, and other lung and eye irritating products. The ultraviolet (radiant) energy of the arc can also decompose trichloroethylene and

perchloroethylene vapours to form phosgene. DO NOT WELD or cut where solvent vapours can be drawn into the welding or cutting atmosphere or where the radiant energy can penetrate to atmospheres containing even minute amounts of trichloroethylene or perchloroethylene.

C) FIRE AND EXPLOSION PREVENTION

Causes of fire and explosion are:

1. Combustibles reached by the arc, flame, flying sparks, hot slag or heated material;
2. Misuse of compressed gases and cylinders.
3. Short circuits.

BE AWARE that flying sparks or falling slag can pass through cracks, along pipes, through windows or doors, and through wall or floor openings, out of sight of the goggled operator.

To prevent fires and explosion: keep equipment clean and operable, free of oil, grease, and (in electrical parts) of metallic particles that can cause short circuits. If combustibles are in the area, do NOT weld. Move the work if practicable, to an area free of combustibles.

Avoid working in paint spray rooms, dip tanks, storage areas, ventilators. If the work cannot be moved, move combustibles away from sparks and heat; or protect against ignition with suitable fire- resistant covers or shields.

Walls, ceilings, and floor near work should be protected by heat resistant covers or shields. Fire watcher must be standing by with suitable fire extinguishing equipment during and for some time after welding or cutting if:

1. appreciable combustibles (including building construction) are within 10m.
2. appreciable combustibles are further than 10m, but can be ignited by sparks.
3. openings (concealed or visible) in floors or walls can expose combustibles to sparks.
4. combustibles adjacent to walls, ceilings, roofs or metal partitions can be ignited by radiant or conducted heat.

After work, check that area is free of sparks, glowing embers and flames. An empty container that held combustibles or that can produce flammable or toxic vapours when heated, must never be welded on or cut, unless the container has first been cleaned. This includes a thorough steam or caustic cleaning (or a solvent or water washing, depending on the combustible's solubility) followed by purging and inerting with nitrogen or carbon dioxide, and using protective equipment.

Water filling just below the working level may substitute for inerting.

A container with unknown contents should be cleaned (see paragraph above). Do NOT depend on sense of smell or sight to determine if it is safe to weld or cut. Hollow castings or containers must be vented before welding or cutting as they can explode.

In explosive atmospheres, never weld or cut where the air may contain flammable dust, gas, or liquid vapours.

ELECTRIC ARC (MIG, TIG) WELDING

Comply with precautions in above, and this section. Arc welding, properly done, is a safe process but a careless operator invites trouble. The equipment carries high currents at significant voltages. The arc is very bright and hot. Sparks fly, fumes rise, ultraviolet and infrared energy radiates and work pieces are hot. The wise operator avoids unnecessary risks and protects himself and others from accidents.

A) BURN PROTECTION

The welding arc is intense and visibly bright. It's radiation can damage eyes, penetrate lightweight clothing, reflect from light coloured surfaces and burn the skin and eyes. Skin burns resemble acute sunburn, those from gas - shielded arcs are more severe and painful.

DON'T GET BURNED! FOLLOW ALL SAFETY PRECAUTIONS!

PROTECTIVE CLOTHING

Wear long sleeved clothing (particularly for gas shielded arc) in addition to gloves, apron and strong shoes. As necessary, use additional protective clothing such as leather jacket or sleeves, flameproof apron, and fire-resistant leggings. Avoid outer garments of untreated cotton. Bare skin protection: Wear dark substantial clothing, Button collars closed to protect the chest and neck and button any pockets to prevent entry of sparks.

EYE AND HEAD PROTECTION

Protect eyes from exposure to arc. NEVER look at an electric arc without protection. Welding helmet or shield containing an appropriate filter plate (Please refer to the section 'Welding Shield'). Place over face before striking arc. Protect filter plate with a clear cover plate. Cracked or broken helmet or shield should NOT be worn; radiation can pass through to cause burns.

Cracked, broken, or loose filter plates must be replaced IMMEDIATELY. Replace clear cover plate when broken, pitted, or spattered. WE SUGGEST you wear flash goggles with side shields under the helmet, to give some protection to the eyes should the helmet not be lowered over the face before an arc is struck. Looking at an arc momentarily with unprotected eyes (particularly high

intensity gas-shielded arc) can cause a retinal burn that may leave a permanent dark area in the field of vision. Before welding whilst wearing contact lenses, seek advice from your optician.

PROTECTION OF NEARBY PERSONNEL

For production welding, a separate, well vented room or enclosed bay is best. In open areas, surround the operation with low reflective, non-combustible screens or panels. Allow for free air circulation, particularly at floor level. Provide face shields for all persons who will be looking directly at the weld. Others working in the area should wear flash goggles. Before starting to weld, make sure that screen or bay doors are closed.

B) TOXIC FUME PREVENTION

Comply with all precautions in 1B.

C) FIRE AND EXPLOSION PREVENTION

Do not overload arc welding equipment. It may overheat cables and cause a fire. Loose cable connections may overheat or flash and cause a fire. Never strike an arc on a cylinder or other pressure vessel. It creates a brittle area that can cause a violent rupture or lead to such a rupture later under rough handling.

D) SHOCK PREVENTION

Exposed live conductors or other bare metal in the welding circuit, or in unearthed, electrically-LIVE equipment can fatally shock a person whose body becomes a conductor. DO NOT STAND, SIT, LIE, LEAN ON, OR TOUCH a wet surface when welding, without suitable protection.

PROTECTION FOR WEARERS OF ELECTRONIC LIFE SUPPORT DEVICES (PACEMAKERS).

Magnetic fields from high currents can affect pacemaker operation. Persons wearing pacemakers should consult with their doctor before going near arc welding or spot welding operations.

E) PROTECTION AGAINST SHOCK

Keep body and clothing dry. Never work in damp area without adequate insulation against electric shock. Stay on a dry duckboard or rubber mat when dampness or sweat can not be avoided. Sweat, sea water, or moisture between body and an electrically LIVE part - or earthed metal - reduces the body surface electrical resistance, enabling dangerous and possibly lethal currents to flow through the body.

1) EARTHING THE EQUIPMENT

When arc welding equipment is earthed according to the National Electrical Code, and the workpiece is earthed, a voltage may exist between the electrode and any conducting object.

Examples of conducting objects include, but are not limited to, buildings, electrical tools, work benches, welding power source cases, workpieces, etc. Never touch the electrode and any metal object unless the welding power source is off. When installing, connect the frames of each unit such as welding power source, control, work table, and water circulator to the building earth. Conductors must be adequate to carry earth currents safely. Equipment made electrically LIVE by stray current may shock, possibly fatally. Do not EARTH to electrical conduit, or to a pipe carrying ANY gas or a flammable liquid such as oil or fuel.

2) TORCH

A fully insulated torch should be used without protruding screws or other damage.

3) CONNECTORS

Fully insulated lock-type connectors should be used to join welding cable.

4) CABLES

Frequently inspect cables for wear, cracks and damage. IMMEDIATELY REPLACE those with excessively worn or damaged insulation to avoid possibly lethal shock from bared cable. Cables with damaged areas may be taped to give resistance equivalent to original cable. Keep cable dry, free of oil and grease and protected from hot metal and sparks.

5) TERMINALS AND OTHER EXPOSED PARTS

Terminals and other exposed parts of electrical units should have insulating covers secured before operation.

6) SAFETY DEVICES

Safety devices such as interlocks and circuit breakers should not be disconnected or shunted out. Before installation, inspection, or service of equipment, shut OFF all power and remove line fuses (or lock or red-tag switches) to prevent accidental turning ON of power. Do not open power circuit or change polarity while welding. If, in an emergency, it must be disconnected, guard against shock burns, or flash from switch arcing. Always shut OFF and disconnect all power to equipment. A power disconnect switch must be available near the welding power source.

PREPARATION OF THE WORKING AREA

The working area must be sufficiently spacious, not humid, and well-ventilated as to avoid any fumes which develop from the welding process and from incidental material adhering to the pieces to be welded (oils, paints, tars...) which may cause danger to the operator.

Avoid welding tanks which may contain flammable residuals.



WARNING: ELECTRIC SHOCK CAN BE FATAL. A PERSON QUALIFIED IN FIRST AID SHOULD ALWAYS BE PRESENT IN THE WORKING AREA. IF PERSON IS UNCONSCIOUS AND ELECTRIC SHOCK IS SUSPECTED, DO NOT TOUCH THE PERSON IF HE OR SHE IS IN CONTACT WITH THE WELDER OR CABLES. DISCONNECT THE WELDER FROM THE POWER SOURCE AND THEN USE FIRST AID. DRY WOOD, OR OTHER INSULATING MATERIAL CAN BE USED TO MOVE CABLES, IF NECESSARY, AWAY FROM THE PERSON.

ADDITIONAL PRECAUTIONS FOR MIG WELDING

1. ALWAYS ensure that there is full free air circulating around the outer casing of the machine, and that the louvres are unobstructed.
2. Welding arc can seriously damage your eyes. Both operator and spectators must ALWAYS use a proper welding face shield or helmet with suitable filter lenses. Proper gloves and working clothes should be worn at all times.
3. ALWAYS check that the pressure regulator and gauges (where fitted), are working correctly. DO NOT lubricate the regulator.
4. ALWAYS use the correct regulator. Regulators are designed to be used with a specific gases.
5. ALWAYS inspect the torch hose before use to ensure it is in good condition.
6. ALWAYS keep the free length of torch hose outside the work area.
7. ALWAYS remove all flammable materials from the welding area.
8. NEVER remove any of the panels unless the machine is disconnected from the supply, AND never use the machine with any of the panels removed.

9. The MIG welding process uses an INERT gas to protect the weld pool. It is important to ensure the appropriate gas is being used. NEVER use gas from a cylinder, the content of which is unknown.

NEVER

- a. Use a damaged cylinder.
 - b. Lift the cylinder by the valve.
 - c. Expose the cylinder to a heat source or sparks.
10. NEVER use or store in a damp environment. DO NOT EXPOSE TO RAIN.
11. ALWAYS keep fire extinguisher handy....'Dry Powder, CO2 or BCF, NOT Water
12. NEVER attempt any electrical or mechanical repair unless you are a qualified technician. If you have a problem with the machine contact your local CLARKE dealer.
13. NEVER continue to weld, if, at any time, you feel even the smallest electric shock. Stop welding IMMEDIATELY and DO NOT attempt to use the machine until the fault is diagnosed and corrected.
14. NEVER point the MIG torch at any person or animal.
15. NEVER touch the MIG torch nozzle until the welder is switched OFF and the nozzle has been allowed to cool.
16. NEVER connect, disconnect, or attempt to service the welding torch, until the machine is switched OFF and disconnected from the mains supply.
17. NEVER allow the earth cable or torch hose to become wrapped around the operator or any person in the vicinity.

A comprehensive range of CLARKE safety equipment for use when welding is available from your local dealer.

Consideration should be given to shielding the supply cable of permanently installed welding equipment, in metallic conduit or equivalent. Shielding should be electrically continuous throughout its length.

The shielding should be connected to the welding power source so that good electrical contact is maintained between the conduit and the welding power source enclosure.

The welding equipment should be routinely maintained according to the manufacturer's recommendations. All access and service doors and covers should be closed and properly fastened when the welding equipment is in operation. The welding equipment should not be modified in any way except for those changes and adjustments covered in the manufacturer's instructions. In particular, the spark gaps of arc striking and stabilizing devices should be adjusted and maintained according to the manufacturers recommendations.

ELECTRICAL CONNECTIONS



WARNING: READ THESE ELECTRICAL SAFETY INSTRUCTIONS FULLY BEFORE CONNECTING THE PRODUCT TO THE MAINS SUPPLY.

This product is provided with a standard 13 amp, 230 volt (50Hz), BS 1363 plug, for connection to a standard, domestic electrical supply. Should the plug need changing, make sure that a plug of identical specification is used.



**WARNING: THE WIRES IN THE CABLE ARE COLOURED AS FOLLOWS:
BLUE = NEUTRAL BROWN = LIVE YELLOW AND GREEN = EARTH**

If the colours of the wires in the power cable do not correspond with the markings on the terminals of your plug, proceed as follows.

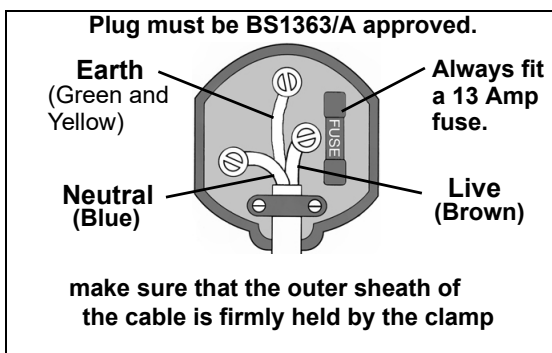

- Connect the **blue** wire to the terminal which is marked **N**.
- Connect the **brown** wire to the terminal which is marked **L**.
- Connect the **Yellow and Green** wire to the terminal which is marked **E** or \perp .



We recommend that this machine is connected to the mains supply via a Residual Current Device (RCD)

If in doubt, consult a qualified electrician. DO NOT attempt any repairs yourself.

SAFETY SYMBOLS

	General Warning. This indicates that failing to follow these instructions could result in injury or damage to the machine.
	Recycle unwanted materials instead of disposing of them as waste. All tools, accessories and packaging should be sorted, taken to a recycling centre and disposed of in a manner which is compatible with the environment.
	Read instruction manual before use.

INVENTORY

Any damage or deficiency should be reported to your CLARKE dealer immediately. **Some of the components are stored within the machine side compartment.**

The components include the following:

- 1 x Mig Welder
- 1 x Welding Shield
- 1 x Carry Handle
- 1 x Pull Handle
- 1 x Handle Cap
- 1 x Handle Fixings Pack
- 3 x Copper Torch Tips - 2 x 0.8 mm, 1 x 1.0 mm (fitted)
- Mild Steel Wire Mini Spool 0.6mm
- Flux cored mild steel wire mini spool 0.9 mm
- 1 x Instruction Manual
- 1 x Wheel Kit

OVERVIEW



NO	DESCRIPTION	NO	DESCRIPTION
1	Pull Handle	6	Earth Clamp
2	Carry Handle	7	Torch Hose
3	Gas Connection Point	8	Torch
4	Wheels	9	Headshield
5	Control Panel	10	

UNPACKING

1. Open the side panel by pushing the latch down and allowing the side panel to drop down.
2. Remove any loose items that have been transported inside such as the handle, wheel kit etc.

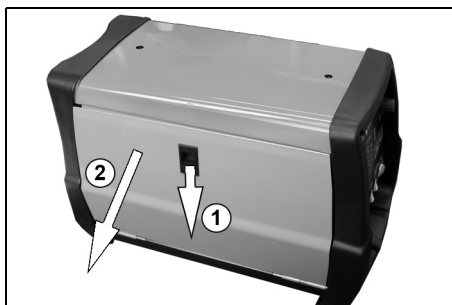

THE CONTROL PANEL



1. Thermal overload light. If the duty cycle is exceeded as a result of welding too long with a high current, the yellow overload light will illuminate and the welder will turn off. When the welder has cooled down (approx. 5 to 10 minutes), the power will be restored and welding can recommence.

2. Power ON/OFF switch. When the power is ON the green switch will be illuminated. When the welder is no longer required, the Power On/Off switch should be switched to the OFF position and the plug should be disconnected from the mains supply.

3. Current setting switches MIN-MAX & 1-2. Used together these two switches provide 4 increasing power levels as follows:

- MIN-1
- MIN-2
- MAX-1
- MAX-2.

4. Wire speed control knob. As a general rule, a higher current requires a higher wire speed.

ASSEMBLING THE WELDING SHIELD

1. The welding shield shown on page 12 is supplied flat for shipping. Fold the sides of the shield around and clip to the top panel.

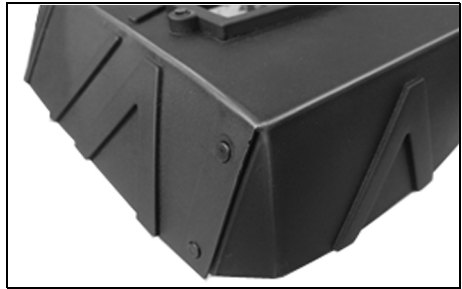

2. Insert both the glass lens panels into the recess inside the shield.
 - The clear glass must be fitted first to face the outside.
3. Insert the two plastic screws and use the plastic wingnuts to clamp the glass panels to the shield.
 - The clear glass panel should be replaced when it becomes badly pitted.

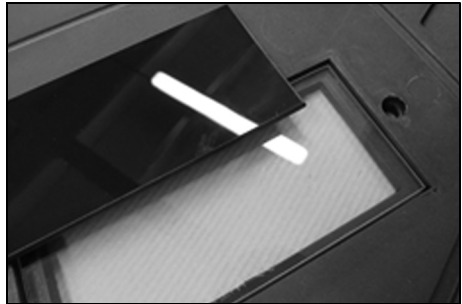

4. When replacing the glass panels, only use parts supplied by Clarke International. The dark panel is a certified, optical glass and should not be exchanged for any other type.
5. Secure the handle in position using the plastic nuts provided.

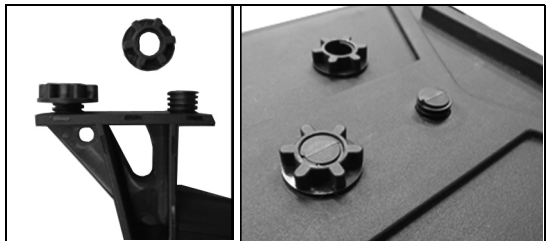

- The handle will be on the inside of the shield.



PREPARATION FOR USE

FITTING THE WHEELS

1. Fit two e-clips onto the axle in the positions shown.

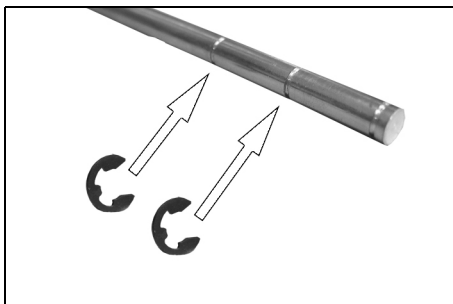

2. Slide the axle into the wheel supports.
3. Fit two e-clips onto the opposite end of the axle in the same positions.

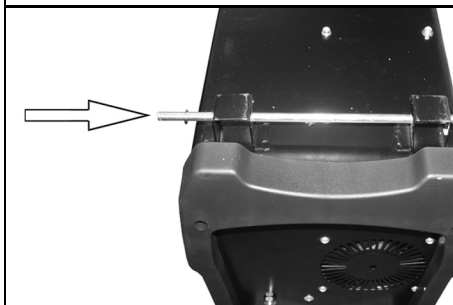

4. Remove the cap on the wheel and slide the wheel onto the axle.

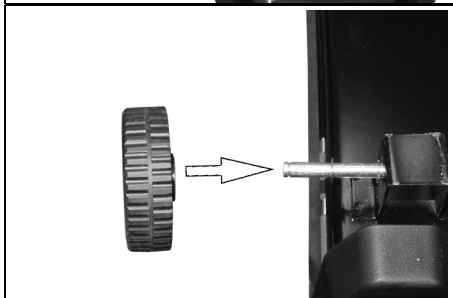

5. Secure the wheel using an e-clip.
6. Replace the wheel cap.

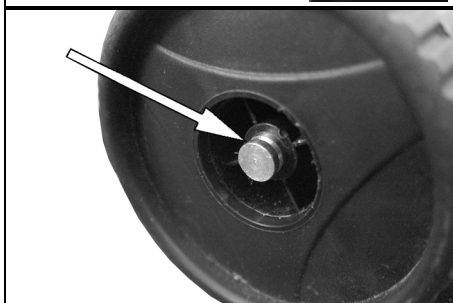

FITTING THE HANDLE

1. Fit the 2 handles together and secure to the top of the welder using the screws and washers supplied.



MOUNTING THE WELDING WIRE SPOOL

Warning: Ensure that the welder is not connected to the mains supply.



NOTE: Spools of welding wire are available from your Clarke Dealer.

1. Open the side panel, by pushing the latch down and allowing the side panel to drop down.
2. Remove the locking knob and retaining disc.
3. Place the spool of welding wire (not supplied) over the spindle so that it sits on the spring.
 - Do not release the tension on the wire as it will unravel causing feeding problems later.
 - The wire will feed off the spool anticlockwise from the bottom of the reel.
 - The spool must be fitted with the correct orientation otherwise it will not feed correctly.

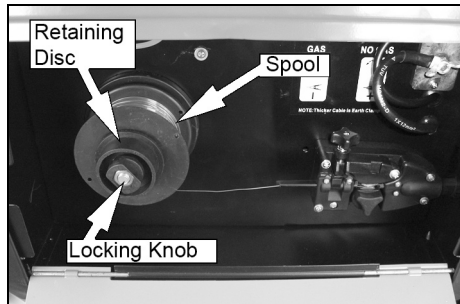

SETTING THE DRIVE ROLLER SIZE

1. Loosen the tensioning knob and pivot it towards you.
2. Lift up the arm.
3. Take hold of the triangular knob on the drive roller cover and rotate it 90° anticlockwise to release it.
4. Pull the roller retainer off the drive spindle to reveal the roller.
5. Pull the roller off the drive spindle.
 - The groove size is stamped on the corresponding side of the roller. Select the groove size according to the size of the wire you are using and put the roller back on the spindle with your chosen side facing you.
6. Replace the drive roller cover back onto the drive spindle with the opening facing right.
7. Ensure that the flanges at the base of the drive roller cover, seat fully into the circular recess in the main moulding and then rotate the drive roller cover through 90° to lock it in place.

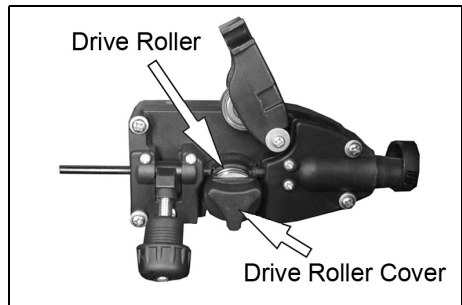
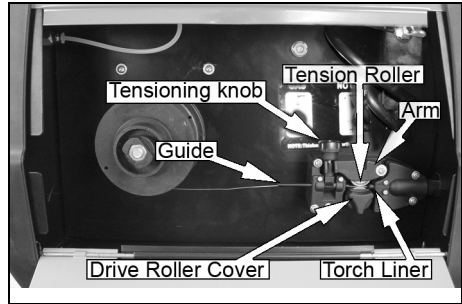

THREADING THE WIRE

IMPORTANT: Do not release the tension on the wire as it will unravel causing feeding problems later.

1. Pull out the end of the wire from the spool, taking care not to release the tension.
 - We recommend you cut off and discard the first 10 cm of wire from the spool to avoid burrs and then straighten the next 15 cm of wire to help with feeding.
2. Loosen the tensioning knob and pivot it towards you.
3. Lift up the arm.

4. Pass the wire through the guide, over the drive roller and into the torch liner.
 - Push about 10-15 cm into the torch liner.
5. Lower the arm and replace the tensioning knob.
 - Tighten the tensioning knob sufficiently to hold firmly, but do not fully tighten.

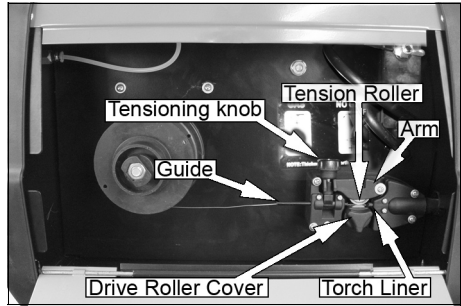

NOTE: Correct tension will allow the wire to feed into the torch liner smoothly, but will allow the drive roller to slip in the event of a blockage.

6. Close the side panel of the welder.
7. Pull off the torch shroud with a twisting movement, then unscrew the contact tip.
8. Connect the welder to the power supply and switch ON.

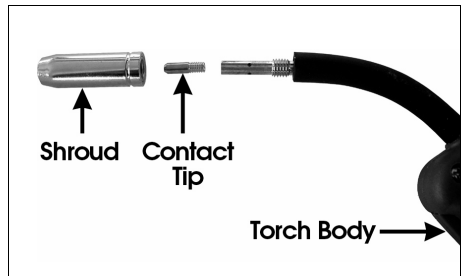

9. Set the 'WIRE FEED' rotary control on the front panel to position 7 or 8 and squeeze the trigger on the torch body.
 - The wire will feed through the hose until it appears at the torch tip.
 - Ensuring the hose is free from kinks during this process will assist the wire in its passage through the hose liner.



10. Release the trigger and switch off the welder and disconnect the machine from the mains supply.
11. Refit the appropriate size contact tip (0.9 mm, for no gas welding is supplied fitted) to suit your wire. then replace the shroud.
 - A spare 0.8 mm tip is supplied loose and should be used when using 0.6/0.8 mm mild steel solid wire.
12. Trim the welding wire so that it protrudes no more than 5 mm from the end of the contact tip.

MIG WELDING PRINCIPLES

MIG (Metal Inert Gas) welding allows you to fuse together two similar metals without altering the properties of the metal.

A consumable wire electrode is continuously fed through the welding torch that is fitted with a concentric gas nozzle. The wire is connected to a high voltage supply which creates an electric arc between the electrode (the wire) and the workpiece. The arc is used to create the required heat to turn the metal into a molten state. The wire is used as both the electrode and as a filler.

The gas is used to prevent oxidation and to shield the arc and the weld from atmospheric contamination. The choice of gas is dependent upon the material being welded, Two types are available from Clarke International.

Carbon Dioxide (CO ₂)	For Mild Steel	Part No. 6000642
CO ₂ /Argon Mix	For thin sheet metal-Mild Steel / Stainless Steel	Part No. 6000660

When using the welder in a gasless configuration the shielding gas is created from the flux within the welding wire.

When using the welder outside, you may need to erect a wind break to make sure the shielding gas is not blown away, thereby leaving a poor quality weld.

GAS/NO-GAS SELECTION

The welder can be configured to weld, with or without a gas supply according to the type of welding wire being used.

- Mild Steel solid core (with gas)
- Flux Cored (no gas)

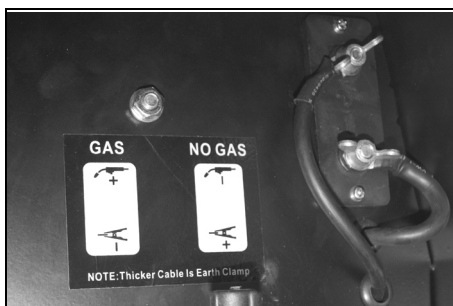

WELDING WITHOUT GAS

1. If using 0.9mm flux cored wire, connect the terminal as shown.
 - The earth cable (Thicker Lead) should be connected to the positive (Red) terminal.
 - The cable from torch (Thinner Lead) should be connected to the Negative (Black) terminal.

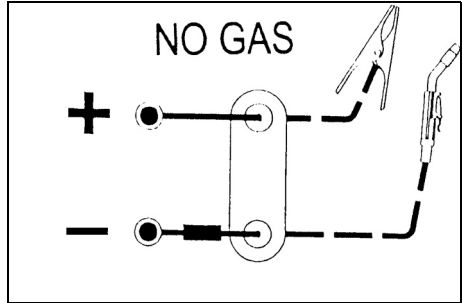

WELDING WITH GAS

1. If using solid cored wire 0.6/0.8mm wire, connect the terminal as shown.
 - The earth cable (Thicker Lead) should be connected to the negative (Black) terminal.
 - The cable from torch (Thinner Lead) should be connected to the positive (Red) terminal.

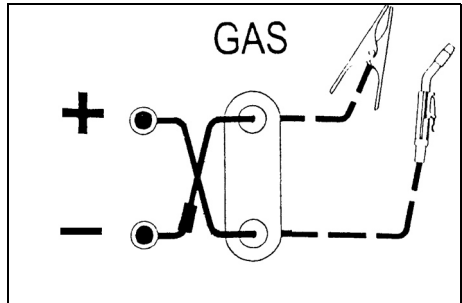

CONNECTING THE GAS SUPPLY

2. Connect a bottled gas supply to the small tube at the back of the welder.

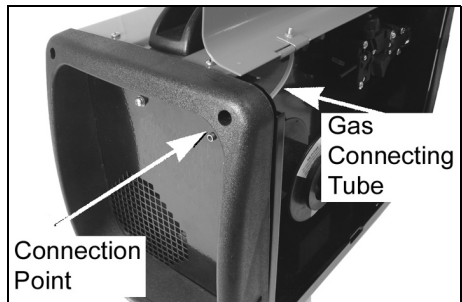

OPERATING THE WELDER

PREPARING THE WORKPIECE

The area being welded should be perfectly clean. Any coating, plating or corrosion must be removed, otherwise a good weld will be impossible to achieve.

Attach the earth clamp to the workpiece as close to the point of weld as possible, without it being intrusive.

OPERATION



CAUTION: THE DUTY CYCLE MUST BE ADHERED IN ORDER TO PREVENT THE THERMAL OVERLOAD PROTECTION FROM ACTIVATING

1. With the welding current set and the wire trimmed, set the wire feed control to 6.
2. Plug the machine into the mains supply and switch on.
3. Cover your face with a welding mask or welding helmet.
 - This is essential.
4. Lower the torch to the workpiece with one hand and approach the work with the torch tip at an angle of about 35° and pull the torch trigger fully.
 - As the wire touches the workpiece an arc will be struck.
5. In order to produce a satisfactory weld, the controls may be fine tuned as required. This will come with practice.

NOTE: MIG welding is an acquired skill. It is strongly advised that, if you are not fully familiar with this type of welding, you practice on a piece of material with the same characteristics as your workpiece until you are satisfied with the result, and you have fine tuned your welder to produce a satisfactory weld.

NOTE: One of the problems experienced with novice welders is the welding wire sticking to the contact tip. This is as a result of the wire feed speed being too slow. It is always better therefore to start with too high a speed and back off slightly to avoid the possibility of the wire welding itself to the tip. This is the reason position 6 is recommended for start up.

NOTE: The Wire Feed control is for fine tuning the wire speed. The speed of wire delivery will increase automatically as the current is increased. Therefore, once the ideal speed is achieved by fine tuning, it should not be necessary to adjust this control when the welding current is changed.

NOTE: Listen to the sound made. An irregular crackling sound denotes too high a wire speed. Decrease the speed until a regular, strong buzzing sound is heard.

THERMAL OVERLOAD

The 'Thermal Overload' shuts off the welder when it becomes too hot, due to the duty cycle being exceeded. This is to prevent any damage to the machine.

When this occurs, the warning lamp shown will light up. Allow the welder to cool until the amber light extinguishes before resuming work.

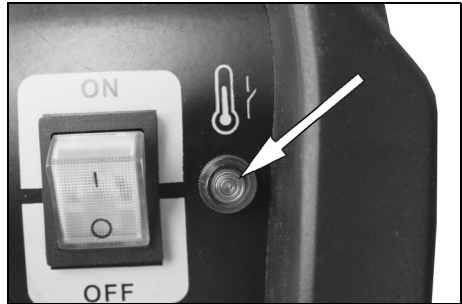





DUTY CYCLE

These welders are covered by regulations EN 60974-1 and EN 50199, where the duty cycle is expressed as a percentage of time the machine may be used in a given period for a specified welding current.

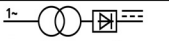
Using the example shown, which is an illustration of the data plate;-

e.g. when welding at 40 amps the machine may be used for 6 minutes (60%) in any 10 minute period.

Clarke[®]weld		Imported by Clarke INTERNATIONAL EPPING, ESSEX CM16 4LG ENGLAND	
MIG145	6014505	Batch No:	
1- 		EN60974 - 1:2005	
		35A/15.75V - 125A/20.75V	
	X	10%	35% 100%
S	U ₀ 21-38VDC	I ₂ (A)	13 72 40
		U ₂ (V)	20.7 17.6 16
	U ₁ = 230V	I ₁ max = 33A	I ₁ eff = 10.8A

WELDING HINTS

- Try to maintain the tip of the nozzle at an angle of approx. 45° and at a constant distance of approx 5-7mm from the workpiece.
- Try to maintain a constant speed of movement with the torch.
- Do not weld in windy conditions or in an area where ventilation is a problem, or where air flow fluctuates.
- ALWAYS keep the wire and nozzle clean...NEVER use rusted wire.
- Avoid sharp bends or kinks in the welding hose.
- Whenever possible, clean out the wire liner with compressed air when replacing the wire spool.
- Periodically remove the dust using LOW PRESSURE compressed air within the casing. Adequate heat dissipation is essential during the welders operation.

MAINTENANCE



WARNING: ELECTRICITY CAN KILL - NEVER TOUCH LIVE ELECTRICAL COMPONENTS.

WARNING: DISCONNECT THE POWER SUPPLY BEFORE ALL INSPECTIONS AND MAINTENANCE OPERATIONS. BEWARE HOT SURFACES.

WARNING: ALWAYS LET THE WELDER COOL DOWN BEFORE ACCESSING INTERNAL COMPONENTS.

Frequency of maintenance operations depends on the operating conditions, how intensively the welder is used and how clean or dirty the welding site is (aggressive environments etc).

Always inspect the earth cable and torch hose before use, to ensure they are in perfect condition and that the earth clamp is clean and secured correctly to the cable.

Check the hose for security and damage.

As a general rule the power supply should be inspected at least annually. Consult your CLARKE dealer for advice if necessary.

Wire feed unit:

The feed roller wire guide plays an important part in obtaining consistent results. Clean the rollers weekly, especially the feed roller groove, removing all dust deposits.

Torch:

Protect the torch hose assembly from mechanical wear. Clean the liner from the machine forwards by using compressed air. If the liner is blocked it must be replaced.

Contact tip:

The contact tip is a consumable item and must be replaced when the bore becomes enlarged or oval. The contact tip **MUST** be kept free from spatter to ensure an unimpeded flow of gas.

To keep the contact tip free from spatter, we recommend the use of anti-spatter spray (6000715) available from your CLARKE dealer.

Torch shroud:

The torch shroud must also be kept clean and free from spatter. Build-up of spatter inside the gas cup can cause a short circuit at the contact tip which will result in expensive machine repairs.

TROUBLESHOOTING

Your CLARKE MIG Welder has been designed to give long and trouble free service. If however, having followed the instructions in this booklet carefully you still encounter problems, the following points should help identify and resolve them.

PROBLEM	CAUSE	SOLUTION
No response from welder.	Check fuses and mains lead.	Replace fuses as necessary. If problem persists return welder to your local dealer.
		Check fuse size.
Welder does not feed wire.	Feed motor has malfunctioned.	Return welder to your local dealer.
Feed motor running but no wire being fed from welder tip.	Insufficient Feed Roller pressure.	Increase roller pressure.
	Burr on end of wire.	Re-cut wire square with no burr.
	Liner blocked or damaged.	Clean with compressed air or replace liner.
	Inferior wire	Use only good "clean" wire.
	Roller worn out.	Replace roller.
Wire welds itself to tip.	Wire feed speed too low.	Unscrew tip, cut wire and fit new tip. Increase wire speed before operating again.
	Wrong size tip.	Fit correct size tip.
Wire feeds into 'birds nest' tangle.	Wire welded to tip	As above plus reduce feed roller pressure.
	Wire liner damaged preventing smooth operation.	Renew wire liner.

PROBLEM	CAUSE	SOLUTION
Loose coils of wire tangle around wire drum inside machine.	Locking knob too slack.	Tighten locking knob slightly. Do not over-tighten.
Erratic wire feed.	Tensioning knob too tight.	Loosen tensioning knob slightly.
	Tension roller worn.	Check and replace if necessary.
	Insufficient pressure on tension roller.	Increase pressure on tension roller. Caution: Do not over-tighten.
	Wire dirty, rusty, damp or bent.	Re-cut wire and ensure it is clean.
	Liner partially blocked.	Clean with compressed air.
Poor quality welds.	Insufficient gas at weld area.	Check that gas is not being blown away by draughts and if so move to a more sheltered work area. If no increase gas supply.
	Rusty, painted, damp, oil or greasy workpiece.	Ensure workpiece is clean and dry.
	Rusty/dirty wire.	Ensure wire is clean and dry.
	Poor earth contact.	Check earth clamp/workpiece connection.
Welder cuts out whilst in use.	Duty cycle exceeded (auto cut-out operates).	Allow welder to cool 15-30 mins before continuing. Note: If duty cycle is continually exceeded, damage to the welder may result and welder output is probably too small for application.

If you have any problems which cannot be resolved by reference to the above, or if you require spare parts for your welder please contact your local Clarke dealer.

RATING PLATE

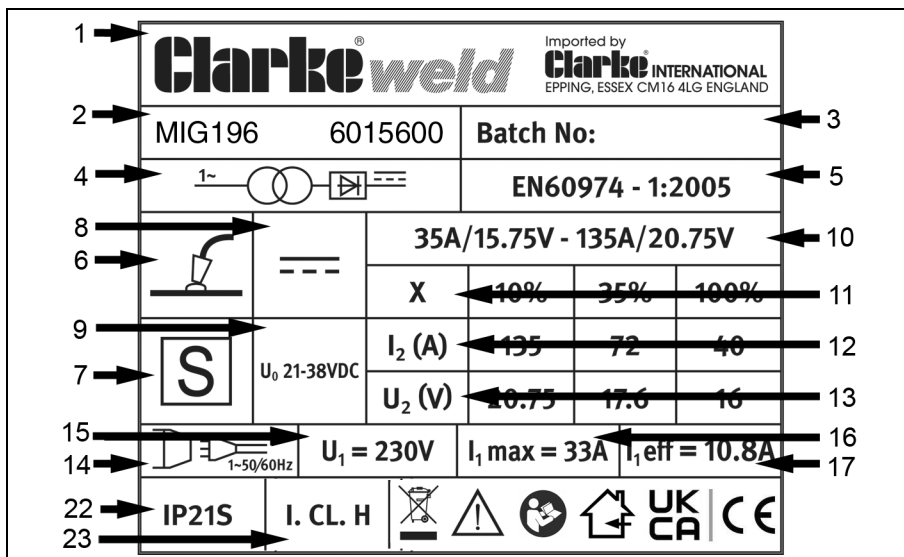

1	Name and address of manufacturer	13	Load Voltage symbol
2	Model number, part number	14	Energy Input symbol
3	Batch number	15	Rated supply voltage
4	Single phase transformer-rectifier	16	Rated maximum supply current
5	British Standards applied	17	Maximum effective supply current
6	Welding process	18	N/A
7	This symbol indicates that the unit is suitable for carrying out welding operations in an environment which has an increased risk of electric shock.	19	N/A
8	Welding Current symbol - direct current.	20	N/A
9	Rated no-load voltage	21	N/A
10	Min+max welding current and corresponding load voltages	22	Degree of protection
11	Duty Cycle symbol	23	Class of protection.
12	Rated Welding Current symbol	24	N/A

SPECIFICATIONS

Model	MIG 196
Part No	6015600
Weight	30.6 kg
Dimensions (l x w x h) mm	500 X 275 X 390
Power Supply	230 V @ 50Hz
IP Rating	IP21S
Output Min/Max Amps	40 /180 Amps
Open Circuit Voltage	21 - 38 V DC
Rated Max Input Current (A)	37
Welding Capacity (Mild Steel)	5-6 mm

CLARKE International reserve the right to change specifications at any time without prior notice.

DUTY CYCLE

The duty cycle determines the machine 'down time'. i.e 10% means 1 minutes operation followed by 9 minutes of rest. **The duty cycle must be adhered to prevent the thermal cutout protection from activating.**

	MIG196		
Duty Cycle (%)	10	60	100
Rated Welding Current (A)	180	74	60
Conventional Load Voltage (V)	23	18	17

Do not exceed the stated duty cycle for this machine. Failure to heed this warning may invalidate your warranty.

CONSUMABLES

The following are some of the accessories available from your CLARKE dealer. Please quote the part numbers shown below:

Part	Description	Part number	Comment
Welding Wire Spools	Flux cored mild steel (mini spool) 0.9mm	8132110	Use for no gas welding
	Mild steel (mini) - 0.6mm	8132100	Use for gas welding
	Mild steel (mini) - 0.8mm	8132070	Use for gas welding
	Stainless Steel 0.8mm (mini spool)	8132090	
Welding Gas	CO2 (250g)	6000642	For welding mild steel
	CO2 (600g)	6000643	For welding mild steel
	CO2/Argon Mix	6000660	For welding stainless/ thin sheet mild steel
Welding Tips	0.6 mm (pack of 5)	8132260	
	0.8 mm (pack of 5)	8132270	
	1.0 mm (pack of 5)	8132275	
Torch Shroud		8133735	
Swan neck		8133740	

A Gas Regulator, Arc, Anti-spatter Spray and Torch Liner are also available from your CLARKE dealer or our parts division.

ARC ACTIVATED HEADSHIELDS

These highly popular headshields activate instantly when the arc is struck and allow you to have both hands free when welding.

Model	Arc Activated	Grinding function	Solar Powered	Fixed Shade	Flip Up	Part Number
GWH4	✓	✓	✓			6000706
GWH7	✓	✓	✓			6000709
GWH5	✓	✓	✓			6000707
GWH6	✓	✓	✓			6000708
GWH3	✓	✓	✓			6000698
GWH2	✓	✓	✓			6000697
PG4	✓	✓	✓			6000716
HS1				✓	✓	6000700
HSF1				✓	✓	6000705

DECLARATION OF CONFORMITY-UK



Hemnall Street, Epping, Essex CM16 4LG

DECLARATION OF CONFORMITY

This is an important document and should be retained.

We hereby declare that this product(s) complies with the following statutory requirement(s):

Electromagnetic Compatibility Regulations 2016.

Electrical Equipment (Safety) Regulations 2016.

The Restriction of the Use of Certain Hazardous Substances in Electrical and Electronic Equipment Regulations 2012

The following standards have been applied to the product(s):

EN 60974-10:2014+A1:2015, EN 60974-1:2012.

The technical documentation required to demonstrate that the product(s) meet(s) the requirement(s) of the aforementioned legislation has been compiled and is available for inspection by the relevant enforcement authorities.

The UKCA mark was first applied in: 2021

Product Description: Mig Welding Machines
Model number(s): MIG145, MIG196
Serial / batch Number: N/A
Date of Issue: 25/06/2021

Signed:

J.A. Clarke
Director

DECLARATION OF CONFORMITY-EU



Clarke[®]
INTERNATIONAL

Fitzwilliam Hall, Fitzwilliam Place, Dublin 2

DECLARATION OF CONFORMITY

This is an important document and should be retained.

We hereby declare that this product(s) complies with the following directive(s):

2014/30/EU *Electromagnetic Compatibility Directive.*
2014/35/EU *Low Voltage Equipment Directive.*
2011/65/EU *Restriction of Hazardous substances.*

The following standards have been applied to the product(s):

EN 60974-10:2014+A1:2015, EN 60974-1:2012.

The technical documentation required to demonstrate that the product(s) meet(s) the requirement(s) of the aforementioned directive(s) has been compiled and is available for inspection by the relevant enforcement authorities.

The CE mark was first applied in: 2008

Product Description: Mig Welding Machines
Model number(s): MIG145, MIG196
Serial / batch Number: N/A
Date of Issue: 25/06/2021

Signed:

J.A. Clarke
Director

A SELECTION FROM THE VAST RANGE OF

Clarke®

QUALITY PRODUCTS



AIR COMPRESSORS
From DIY to industrial, Plus air tools, spray guns and accessories.

GENERATORS
Prime duty or emergency standby for business, home and leisure.

POWER WASHERS
Hot and cold, electric and engine driven - we have what you need

WELDERS
Mig, Arc, Tig and Spot. From DIY to auto/industrial.

METALWORKING
Drills, grinders and saws for DIY and professional use.

WOODWORKING
Saws, sanders, lathes, mortisers and dust extraction.

HYDRAULICS
Cranes, body repair kits, transmission jacks for all types of workshop use.

WATER PUMPS
Submersible, electric and engine driven for DIY, agriculture and industry.

POWERTOOLS
Angle grinders, cordless drill sets, saws and sanders.

STARTERS/CHARGERS
All sizes for car and commercial use.



PARTS & SERVICE: 0208 988 7400

Parts Enquiries
Parts@clarkeinternational.com

Servicing & Technical Enquiries
Service@clarkeinternational.com

SALES: UK 01992 565333 or Export 00 44 (0)1992 565335

Clarke® INTERNATIONAL Hemnall Street, Epping, Essex CM16 4LG
www.clarkeinternational.com